



DALI-2 Display 4"

Datasheet

DALI-2 Control System

Multifunctional DALI-2 control
and operating unit

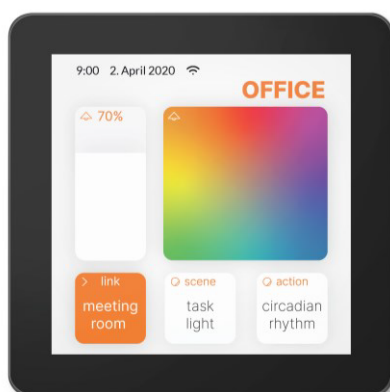

DALI-2 Display 4"

Art.Nr.: 86456841-W (white)

DALI-2 Display 4" plus

Art.Nr.: 86456841-P-W (white)

black or colour version on request

DALI-2 Display 4" Multifunctional Control Device

Overview

- Multifunctional control device for DALI and DALI-2 systems
- 4" capacitive touchscreen with 24-bit color depth
- Dimensions: 88 x 88 x 8.5mm
- comfortable operation via numerous widgets
- customisable user interface
- **coming soon:** integration via WLAN in building management systems
- dimming and switching of groups and individual addresses
- Tunable White and RGB colour management
- recall and saving of scenes.
- Multi-master capable: Several modules can be installed within a DALI circuit.
- Easy installation: the device can be installed on a flush-mounted installation box

Additional functionality of the Display 4" plus:

- addressing and set-up of DALI systems
- creating groups
- visualisation of sensor values such as temperature, air quality, air pressure, humidity, etc.
- control of blinds

Specification, Characteristics

Type	DALI Display 4" (plus)
article number	86456841 86456841-P
GTIN	9010342013560

Electrical data:

rated supply voltage display	24-56V DC
power consumption	3W
number of DALI lines	1
Current consumption DALI-line	<2mA
Interface	DALI

Mechanical data:

ambient temperature	-10...50°C
type of protection	IP20
dimensions L x W x H	88 x 88 x 8.5mm
touchscreen size	4"
touchscreen pixel	480x480px
colours	24Bit
colour display frame	white (black or special colour on request)
colour housing	white (black or special colour on request)

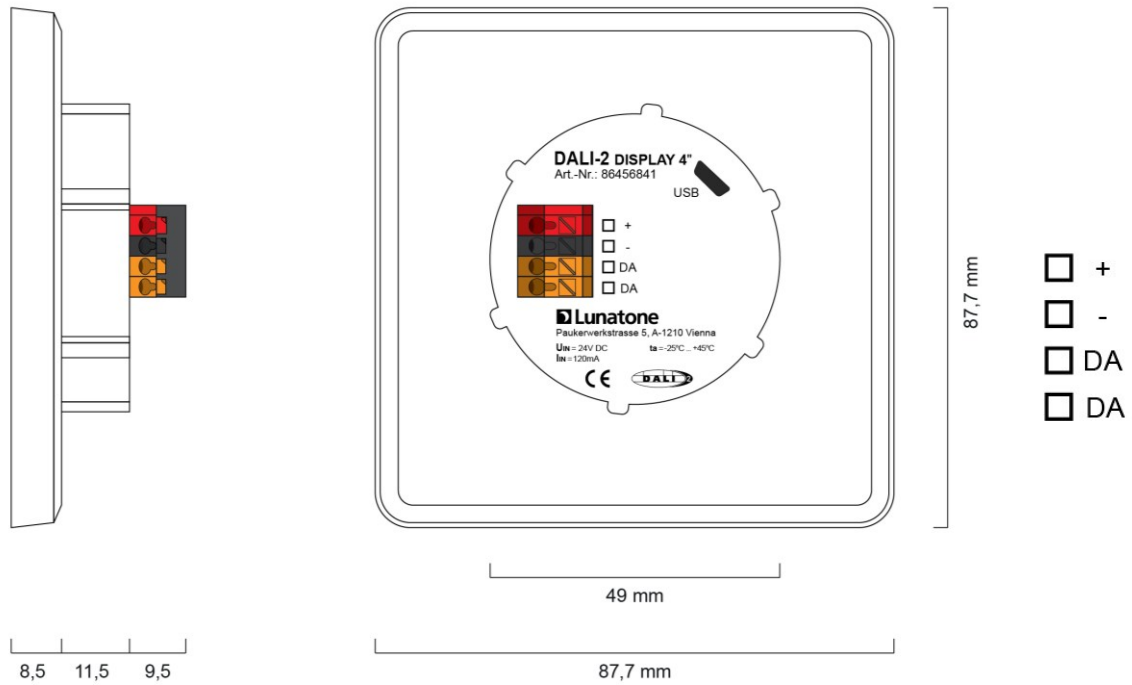

Dimensions Art.Nr.: 86456841-...

connection plan

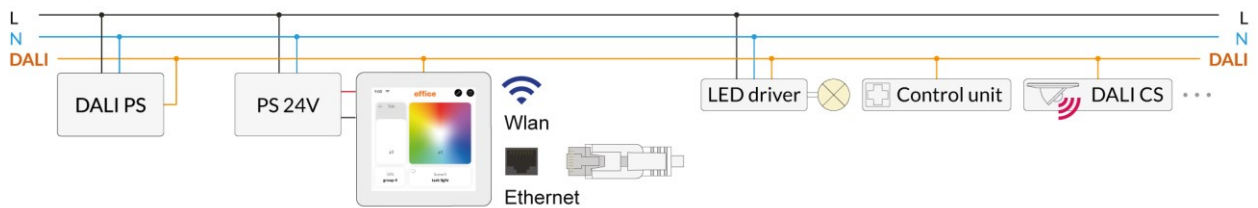

Figure 1 Typical Application

Usage

The DALI display is used for set-up (Version Display 4" plus), configuration and control of a DALI system. The DALI protocol standard IEC62386, is used to control the lighting equipment.

Via the display interface all luminaries, groups, individual addresses can be controlled, and scenes can be recalled.

The user interface can be customized, including background images and colour, function, position, size of control widgets and more.

Typical application

See Figure 1 on page 3.

Installation

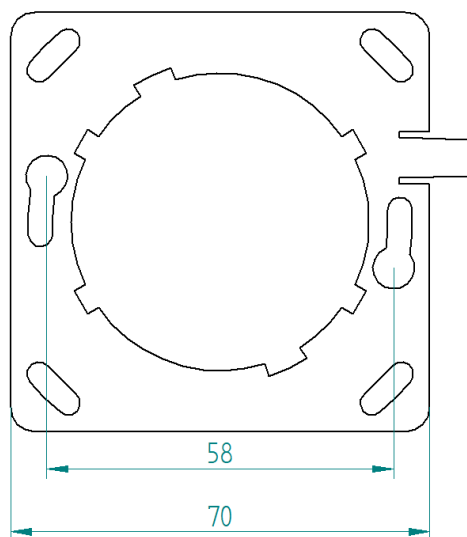

Figure 2 mounting plate

- The DALI-2 Display can be directly connected to the DALI bus. A DALI bus power supply (e.g. DALI PS) is required.
- The device requires an additional 24V supply, which is connected to the corresponding terminals. (suitable power supply unit: PS 24V, 300mA Art.Nr.: 24166012-24HS)
- The connection to the DALI terminals can be made regardless of polarity. The bus input is protected against overvoltage (mains voltage).
- The wiring should be carried out as a permanent installation in a dry and clean environment.
- Installation may only be carried out in a voltage-free state of the system and by qualified specialists.
- National regulations for setting up electrical systems must be followed.
- The DALI wiring can be realised with standard low-voltage installation material. No special cables are required.
- Only 1 wire may be connected to each terminal. When using double wire end ferrules, the connection capacity of the terminal must be considered.

Attention: The DALI-signal is not classified as SELV circuit (Safety Extra Low Voltage). Therefore, the installation regulations for low voltage apply.

The voltage drop on the DALI line must not exceed 2V at maximum length (300m) and maximum bus load (250mA).

Mounting

The DALI Display 4" can be attached to a standard flush-mounted installation box/ electrical socket using the mounting plate (included), see Figure 2, page 4.

For assembly, the mounting plate has to be attached to the electrical socket, the marking: ↑ **TOP** has to face upwards. Rotate the Display approx. 5 ° clockwise and slide it into the cut-out (center circle). Rotate the Display 5 ° counterclockwise to clamp it in a horizontal position.

The display is correctly installed when the clip on the right side falls into the recess provided -> click sound.

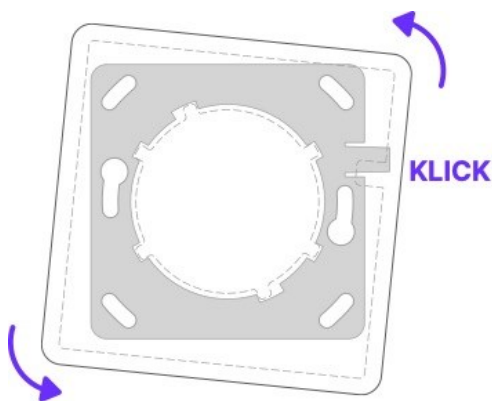

Figure 3 Mounting

To demount the Display, the clip on the right side can be pushed back with a tool and the display can be released again by turning it clockwise.

Safety instructions

- The device is only suitable for indoor installation.
- Keep the product away from liquids and moisture.
- Cleaning is possible with a dry duster. Please do not use abrasives or solvents. Avoid contact with liquids.
- The housing is made of glass and metal, contact with sharp-edged objects can damage the display.
- If the device is defective, send it to Lunatone Industrielle Elektronik GmbH. Under no circumstances should the display be opened. Dismantling / disassembling the display can lead to damage and / or injuries.

Recycling

This product has been designed and manufactured using high quality materials and components that can be recycled and reused.

The device must be disposed of separately from household waste. Please follow the local regulations for the separate disposal of electronic products. The correct disposal of old devices protects our environment.

Functionality and Features

The DALI-2 Display serves as a universal module for **control** of a DALI system, as well as **set-up and configuration** for version Display 4" plus.

By default, the display shows the **user interface for light control**. The user interface of the DALI display is made up of individual pages (boards) and the operating elements (widgets) on them.

Boards: Any number of boards (pages) can be created, these can be reached by swiping your finger to the right / left or using a link widget. The length of the board is flexible: with an up / down swipe of your finger, you can navigate up and down.

Widgets: Any number of widgets can be created for each board. These can be flexibly arranged on the board.

The user interface can be edited using the pencil symbol at the top right. See section: Editing the user interface on page 9.



Button: edit user interface

The **set-up and configuration menu** can be opened with the menu button at the top right. General settings and DALI device settings can be found there. See section: Set-up and system configuration on page **Error!** **Bookmark not defined..**



Menu button



Figure 4 User Interface for Light Control DALI Display 4"

Set-up and configuration Menu

The configuration menu can be reached via the menu button at the top right. 

The configuration menu contains settings for boards, general settings, and settings for the DALI system.

Navigation and menu items

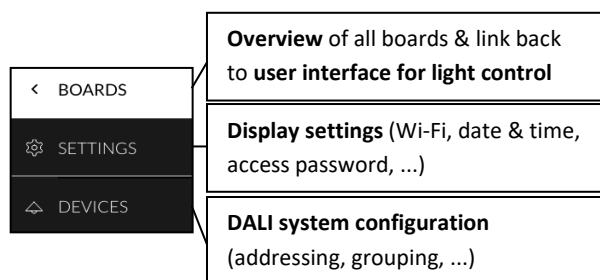

Menu item: Boards

This tab provides an overview of the existing boards and their management.

The pen button at the top right enables the configuration options: renaming, reordering, removing and adding of boards. See section: Boards on page 9.

Clicking on the board tab again will open the interface for light control. Alternatively, clicking on one of the boards, will open the corresponding user interface.

Menu item: Display Settings

General settings for the display can be made here:

- Save/Load: saving and loading display settings and boards
- General: Information on firmware version
- Date & Time: setting the time zone, date and time
- Wi-Fi: establishing an internet connection and displaying the IP address

- Access, Display Passwords: restricting access to the configuration menu and blocking the editing mode with slider and password entry – it takes effect as soon as you switch to the user interface. (Master password: 1210)

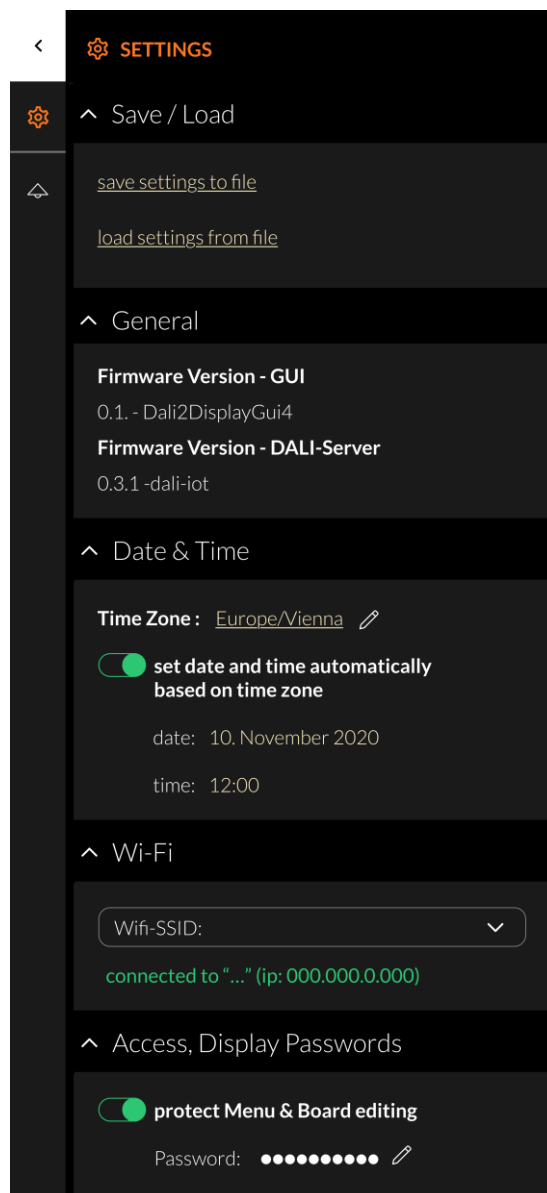

Figure 5 Overview Menu item: Display Settings

Menu item: Devices 

The tab includes set-up and configuration options for the DALI system. Addressed and configured DALI devices of the connected DALI bus are read and listed here.

The DALI Display 4" plus additionally supports addressing/readdressing as well as DALI system extensions.

With the Display 4" plus the devices found can be grouped.

After the configuration has been completed, the user interface for light control can be created, containing boards and widgets for individual addresses, groups, and scenes.

Addressing devices

Select "addressing - search" at the top right (within the menu item "devices").

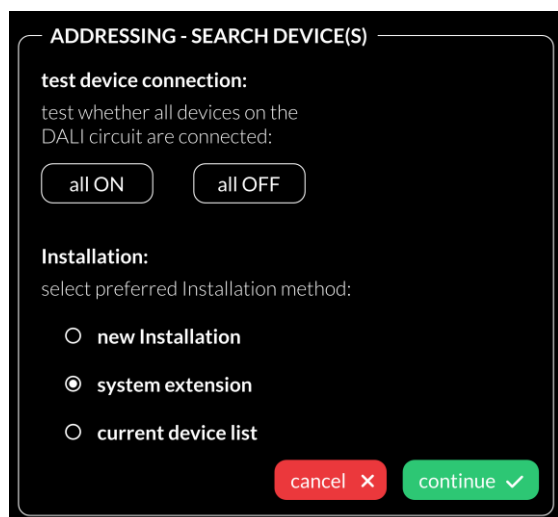

Figure 6 Pop-up addressing, search for devices

Function test: The on and off button can be used to test whether all DALI devices are connected. If all devices respond properly, addressing can be continued (if the devices do not respond check the DALI bus power supply and the device wiring).

Available options:

- current device list: loads already addressed DALI bus

additional options for the Display 4" plus:

- New Installation: for new installations or re-addressing; new addressing of all devices on the DALI bus. (devices that already had an address will also get a new address).
- system extension: if devices were added to an existing system; the existing system keeps its addresses and new addresses will be added.

After reading out/addressing, all devices are displayed in the device list.

Assign device name: Click on the respective device name in the device list

Assign groups: - Version Display 4" plus Click on the respective group entry ("select") in the device list to add the device to the corresponding groups.

State: click on the state symbol to switch the respective devices on and off (for easy localization).

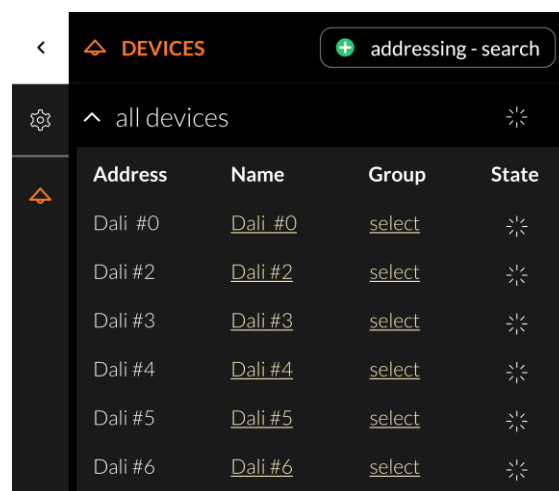





Figure 7 Menu item "Devices"

Edit user interface for light control

The user interface of the DALI Display is made up of individual pages (boards) and the operating elements (widgets) on them.

Boards

An Overview to all boards can be found in the configuration menu  at section BOARDS . To **create, delete, duplicate, or move** a board: select the edit symbol  next to the title BOARDS.

- Create new boards -> button at the top left "new board".
- Edit board: click the pencil symbol  in the board window: rename, duplicate (including or excluding the widgets) or delete.
- Change the order of the pages: select board (blue highlight) move with drag and drop.

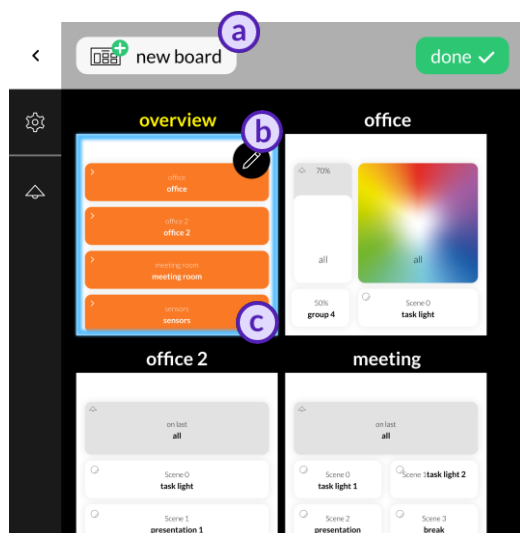



Figure 8 Menu item "Boards"

Close the board setting via the done button: . Return to one of the user interfaces by selecting the respective board.

Editor: edit boards and widgets Menu and Board overview





Editor: Widgets and Background Images

On the user interface: Click on the editor icon: .

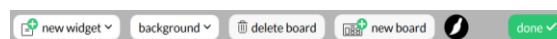
If the icon is not visible, check the settings in the menu: -> Settings -> Access, Display Passwords -> protect Menu & Board editing.



Widgets can be added:

 new widget , details see page 10.

or a background image can be loaded:

background , details see page 10.

boards can be added or deleted:

 delete board  new board

The paintbrush button  enables editing of the board style. Different colours can be assigned to the background and toolbar.

Load background images

A network connection is necessary, to set up the connection open the menu, tab: Settings -> Wi-Fi.

The transmission of images to the display is possible via the IP address of the display with a web browser. To do so, the PC must be in the same network and address range as the display (display of the IP address under Settings -> Wi-Fi).

upload interface on the web-browser (tab upload):

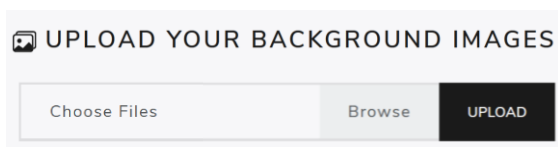

The background image should have the dimensions 1361x1361 and a resolution of 72dpi, RGB.

As soon as the image has been uploaded, it can be accessed on the Display by clicking on "background".

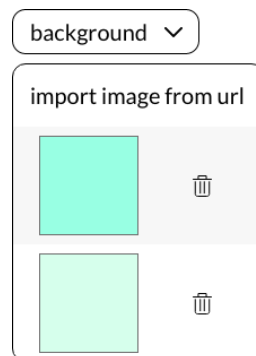

An individual background image can be assigned to each board.

Create a widget

In the user interface for light control: Click on the editor icon: and select "new widget".

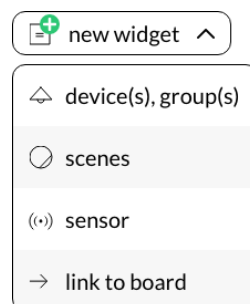

The following widget types are available, see Figure 9 and 10.

The sensor widget (version: Display 4" plus) provides measurement and visualization of temperature, air pressure, humidity and air quality.

The appearance of the widgets is configurable, so widgets on your display may look different.

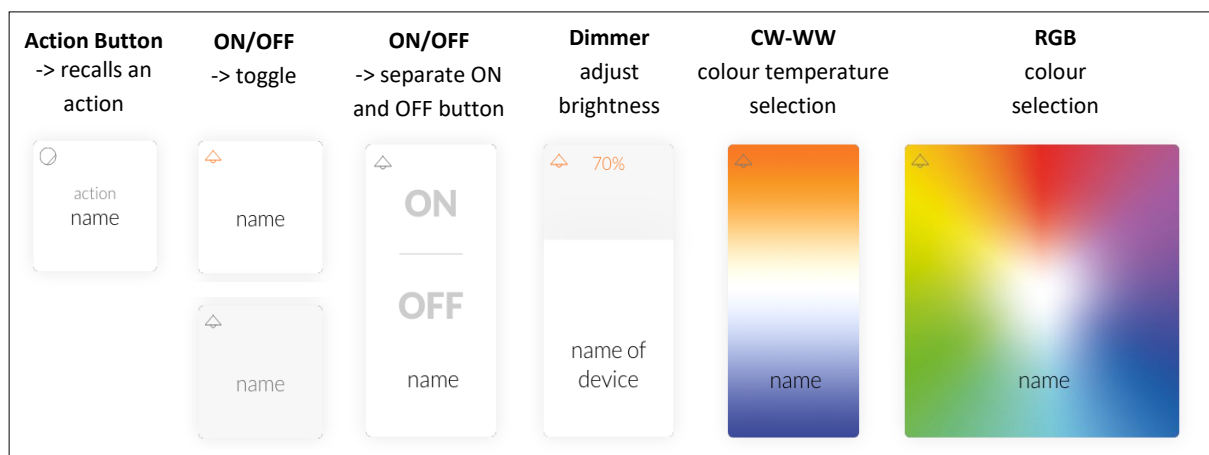

Figure 9 Widgets for devices and groups

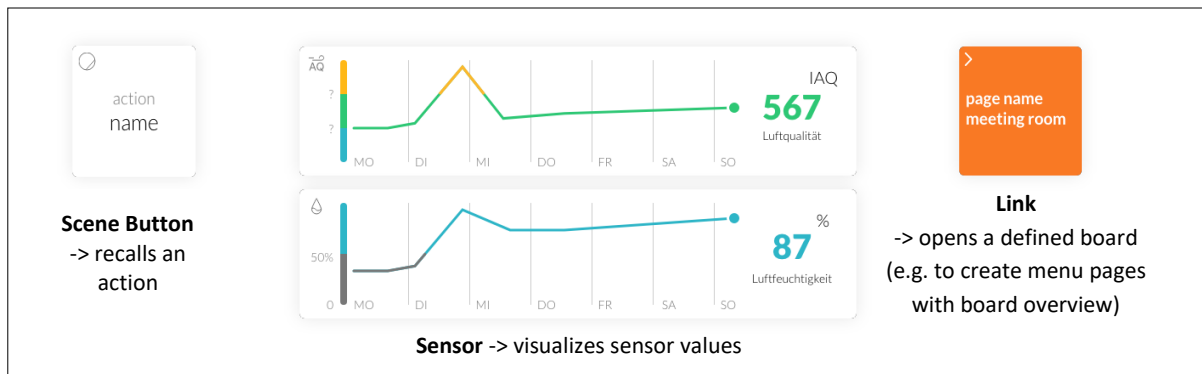

Figure 10 Widgets for scenes, sensors and links

Dialog box “New Widget”

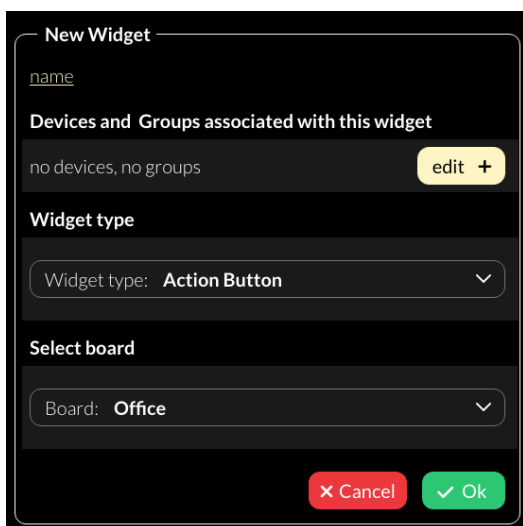



Figure 11 Pop-up “New Widget”

1. Define the name of the widget,
2. Select the devices and groups to be controlled.
3. Select / change the widget type,
4. Depending on the widget type, further settings can be made e.g. defining an action.
5. Select the board on which the widget should be displayed

Edit Widget

In the user interface for light control: click on the editor icon  select the widget to edit:

Pencil icon:

- edit (opens dialog box: “create widget”)
- duplicate
- delete

Brush icon:

- edit style
- copy style
- assign style
- more (more style related options)

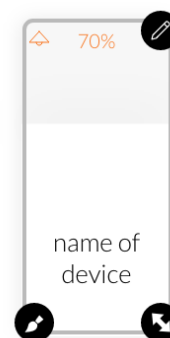

With the style colours and form of the widgets can be customized.

Arrow icon:

- drag the arrow key to change the widget size.

Drag and Drop:

- hold and move to change the order of the widgets.

Create scenes

The scene widget makes it possible to save the current light status (brightness, color temperature, color) in one of the 16 different scenes. To do so:

- Create a scene widget (with the intended scene number and effective range), see page 10.
- Set up the room lighting as desired for the scene (using for example the widgets on the Display). When set, long press the previously created scene widget -> a window appears to save the scene settings.

Firmware Update

An internet connection is necessary: menu item "Settings" -> Wi-Fi.

A firmware update is possible via the IP address of the display with a web browser. To do so, the PC must be in the same network and address range are located like the display (IP address display under "Settings" -> "Wi-Fi")

The configuration file can be uploaded in the web browser under the "Update" tab and the

update can be started using the "Upload" button see Figure 12.

The update can take up to 15 minutes. After an automatic restart of the display, the update is complete.

Save and Load Configuration Files

The display configuration can be saved in the display menu ☰ under "Settings" - in the "Save / Load" tab. The configuration file includes all settings, boards and widgets.

The saved configurations can be downloaded in the web browser under "Download" e.g., to transfer created display user interfaces to other displays.

The files can be uploaded to a display in the web browser –under the respective display IP - tab "Upload".

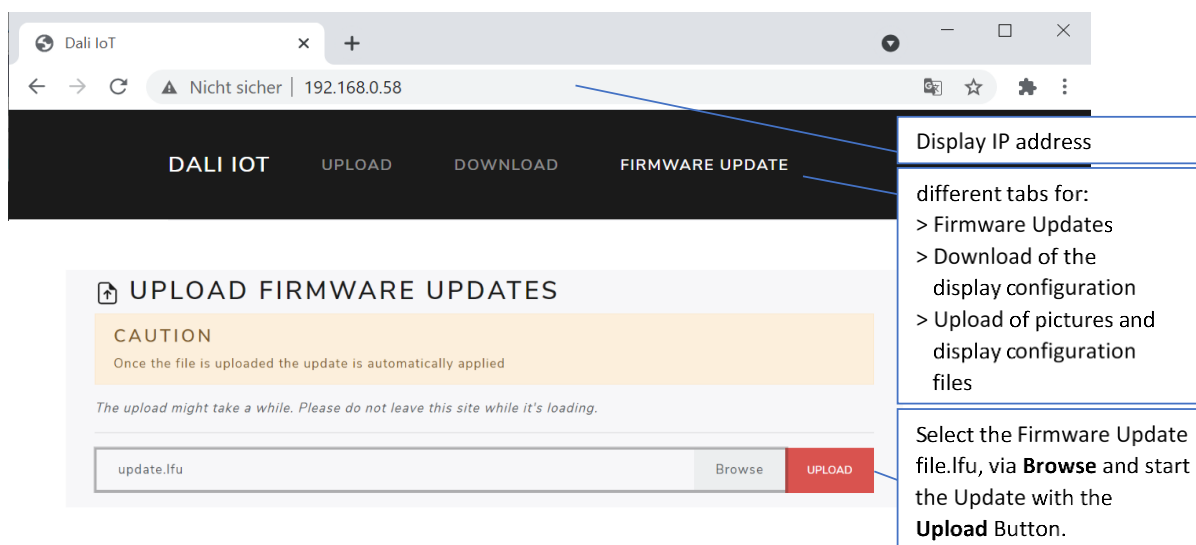

Figure 12 Web browser: Display Firmware Updates

Version Overview

	Display 4" 86456841	Display 4" Plus 86456841-P
customisable user interface	✓	✓
Integration via WLAN	✓	✓
dimming and switching	✓	✓
Tunable White and RGB colour management	✓	✓
configuration of scenes	✓	✓
configuration of groups		✓
integrated sensors for measurement and visualisation of sensor values such as temperature, air quality, air pressure and humidity		✓
addressing and set-up of DALI systems		✓

Purchase Information

Art.Nr.: 86456841-W

DALI-2 Display 4", white
capacitive touchscreen with 24-bit colour depth, control unit for 64 DALI addresses, customisable user interface
white, 88x88x8.5mm
GTIN 9010342013768

Art.Nr.: 86456841-P-W

DALI-2 Display 4" plus, white
capacitive touchscreen with 24-bit colour depth, control unit for 64 DALI addresses, customisable user interface, advanced features: addressing, configure groups and scenes, control blinds, measure and visualize temperature, air-quality, air-pressure, and humidity
white, 88x88x8.5mm
GTIN 9010342013768

On request:

Art.Nr.: 86456841-B

DALI-2 Display 4", black
capacitive touchscreen with 24-bit colour depth, control unit for 64 DALI addresses, customisable user interface
black, 88x88x8.5mm
GTIN 9010342013775

Art.Nr.: 86456841-P-B

DALI-2 Display 4" plus, black
capacitive touchscreen with 24-bit colour depth, control unit for 64 DALI addresses, customisable user interface, advanced features: addressing, configure groups and scenes, control blinds, measure and visualize temperature, air-quality, air-pressure, and humidity
black, 88x88x8.5mm
GTIN 9010342013775

Additional Information and Equipment

Art.Nr.: 24166012-24HS

PS 24V, 300mA – fitting power supply

Lunatone DALI products

<https://www.lunatone.com/en>

Lunatone Datasheets and Manuals

<https://www.lunatone.com/en/downloads-a-z/>

Contact

Technical Support:

support@lunatone.com

Requests:

sales@lunatone.com

www.lunatone.com



Disclaimer

Subject to change. Information provided without guarantee. The datasheet refers to the current delivery.

The function in installations with other devices must be tested for compatibility in advance.